

# Econo Giant

## Econo Giant

The **Econo Giant** is an affordable, versatile stand in silver with sleek black endcaps. With a heavy-duty aluminum base and a variety of height options up to 10', the **Econo Giant** provides many options to choose from.



shown at maximum and minimum heights

## features and benefits:

- Comes complete with base, snap top rail, hybrid bungee/telescopic pole and carry bag
- 10' tall maximum graphic height option
- 6' tall minimum graphic height option
- Heavy-duty, weighted stand
- Anodized silver finish
- Carry bag included
- Twin swivel feet for excellent balance and stability
- 90 day warranty against manufacturer defects

## dimensions:

Hardware	Graphic
<b>Assembled unit:</b> maximum: 36" w x 3.75" d x 126.5" h 914mm(w) x 95mm(d) x 3216mm(h)  minimum: 36" w x 3.75" d x 72.5" h 914mm(w) x 95mm(d) x 1842mm(h)	<b>Visible dimensions:</b> maximum: 36" w x 122" h 914mm(w) x 3099mm(h)  minimum: 36" w x 68" h 914mm(w) x 1727mm(h)  Refer to related graphic template for more information
Shipping	
<b>Shipping dimensions - ships in one box</b> 42" l x 4" w x 6" h 1060mm(l) x 105mm(w) x 150mm(h)	
<b>Approximate shipping weight:</b> 11 lbs / 5 kgs	

## additional information:

**Graphic materials:**  
 13 oz flatmaxx vinyl or premium  
 100% opaque fabric

We are continually improving and modifying our product range and reserve the right to vary the specifications without prior notice. All dimensions and weights quoted are approximate and we accept no responsibility for variance. E&OE. See Graphic Templates for graphic bleed specifications.

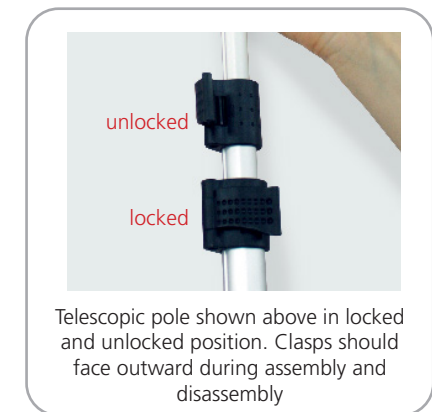
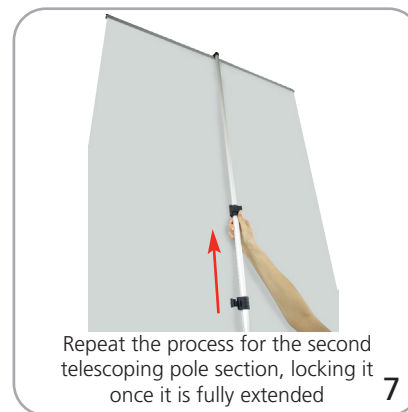
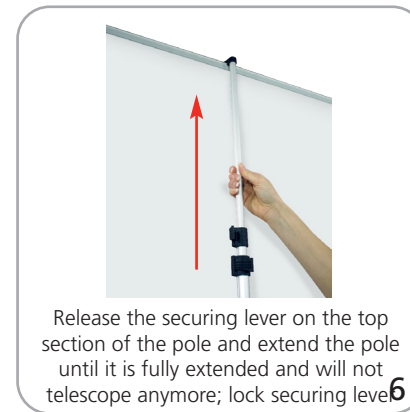
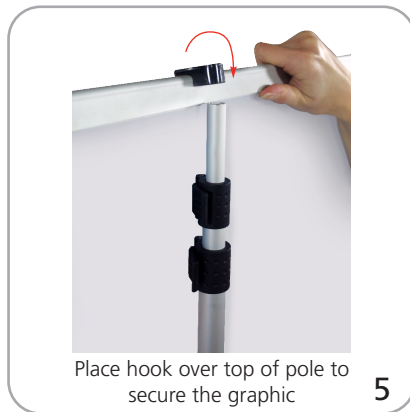
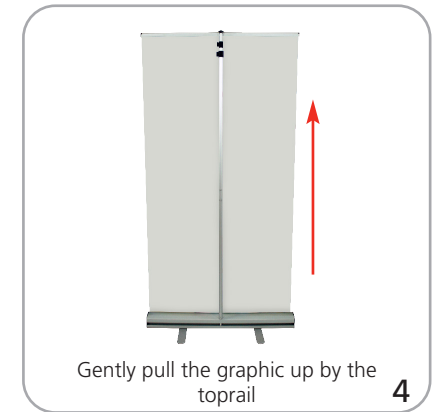
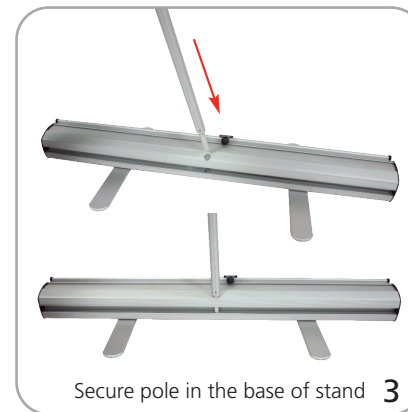

\*To disassemble from maximum height, second section of telescopic pole should be retracted first. Slowly guide the pole down towards the base and repeat with the first pole section.

### Graphic to top rail attachment

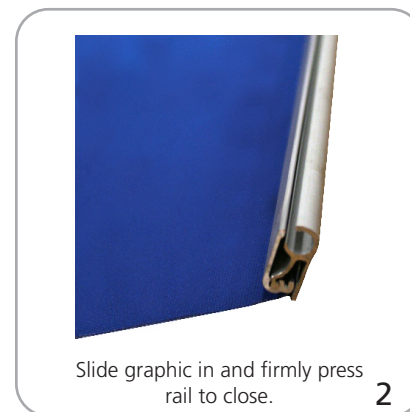

### Graphic to base attachment

